

POWER MANAGEMENT

Features

- Input voltage range — 2.8V to 5.5V
- Programmable LED current up to 30mA
- Current-mode PWM control — 800kHz
- Soft-start to reduce in-rush current
- PWM dimming — 100Hz to 50kHz
- PWM dimming at ISET — Analog and filtered
- Over-voltage protection — 38V (minimum)
- Under-voltage lockout (UVLO)
- Thermal shutdown
- Shutdown current — <math><0.1\mu\text{A}</math> (typical)
- Ultra-thin package — 2mm x 2mm x 0.6mm
- Lead-free package, WEEE and RoHS compliant

Applications

- DSLR, DSC, and Video Cameras
- Cellular handsets
- Portable media players
- Personal navigation systems
- Satellite radio
- Handheld video games

Description

The SC4538 is designed to regulate current for a series string of white LEDs in LCD backlighting applications where small size and high efficiency are priorities. This device integrates an 800kHz current-mode PWM boost converter and a 30mA programmable low dropout current sink regulator.

An external resistor sets the LED current up to 30mA. PWM dimming (100Hz to 50kHz) may be applied directly to the enable (EN) pin, or dimming can be controlled by applying an analog signal to the ISET circuit. The boost circuit can output up to 38V (guaranteed) to drive up to 10 LEDs in series. The current regulator protects against shorts between the BL and OUT pins and also eliminates backlight glow during shutdown when using LEDs with high leakage. Under-voltage lockout and thermal shutdown provide additional protection. A small external capacitor and series resistor control soft-start and loop compensation. Over-voltage detection protects the SC4538 if the BL pin is floating or shorted to ground.

The SC4538 is available in an MLPSD-8 pin 2mm x 2mm x 0.6mm package, with a rated temperature range of -40°C to +85°C.

Typical Application Circuit

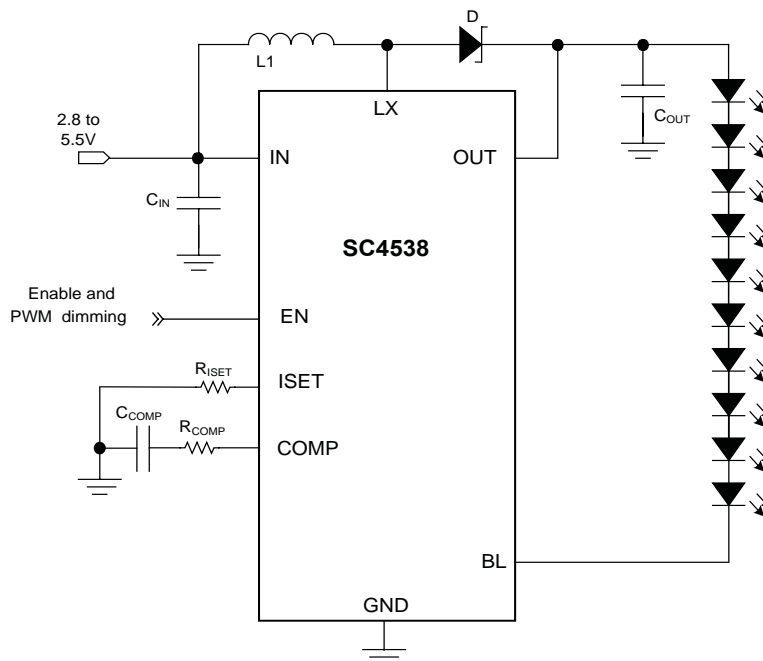

Pin Configuration

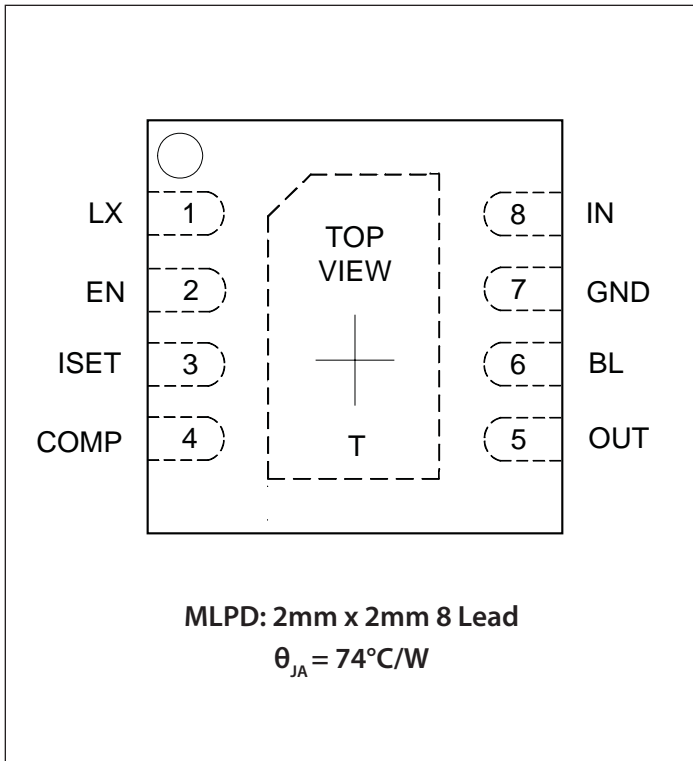

Ordering Information

Device	Package
SC4538ULTRT ^{(1) (2)}	MLPD-UT-8 2x2
SC4538EVB	Evaluation Board

Note:

- (1) Available in tape and reel only. A reel contains 3,000 devices.
- (2) Lead-free package only. Device is WEEE and RoHS compliant.

Marking Information

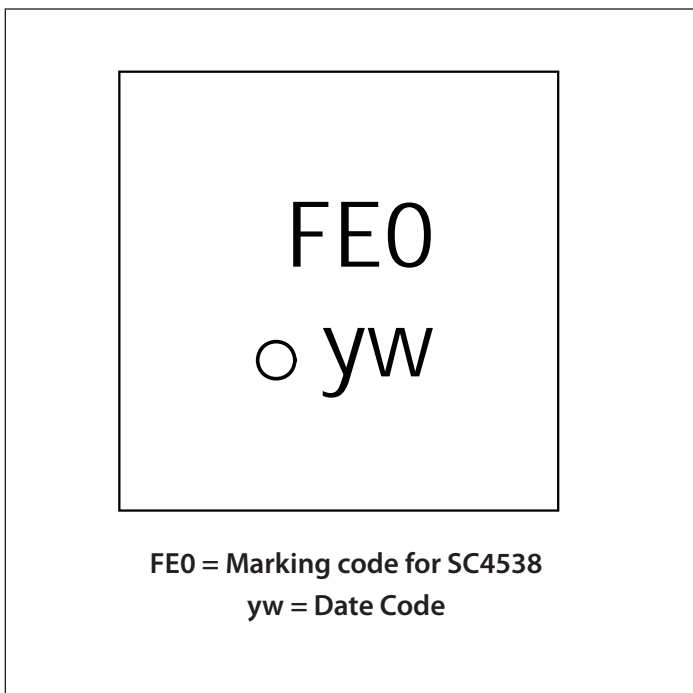

Absolute Maximum Ratings

Supply Voltage (V)	-0.3 to +20.0
LX Voltage, Output Voltage (V)	-0.3 to +45
Current Sink Voltage (V)	-0.3 to +45
Enable Voltage (V)	-0.3 to ($V_{IN} + 0.3$)
Compensation Voltage (V)	-0.3 to +2.0
Current Set Voltage (V)	-0.3 to +2.0
ESD Protection Level ⁽¹⁾ (kV)	2

Recommended Operating Conditions

Supply Voltage (V)	2.8 to 5.5
Output Voltage (V)	5 to 38
Ambient Temperature Range (°C)	-40 to +85

Thermal Information

Thermal Resistance, Junction to Ambient ⁽²⁾ (°C/W)	74
Maximum Junction Temperature (°C)	+150
Storage Temperature Range (°C)	-65 to +150
Peak IR Reflow Temperature (10s to 30s) (°C)	+260

Exceeding the above specifications may result in permanent damage to the device or device malfunction. Operation outside of the parameters specified in the Electrical Characteristics section is not recommended.

NOTES:

- (1) Tested according to JEDEC standard JESD22-A114-B.
- (2) Calculated from package in still air, mounted to 3 x 4.5 (in), 4 layer FR4 PCB with thermal vias under the exposed pad per JESD51 standards.

Electrical Characteristics

Unless otherwise noted: $V_{IN} = 3.6V$, $C_{IN} = 2.2\mu F$, $C_{OUT} = 1\mu F$, $C_{COMP} = 47nF$, $R_{COMP} = 1.27k\Omega$, $R_{ISET} = 5.76k\Omega$, $L = 22\mu H$, $T_A = -40$ to $85^\circ C$, typical values are at $T_A = 25^\circ C$.

Parameter	Symbol	Conditions	Min	Typ	Max	Units
UVLO Threshold	V_{UVLO}	V_{IN} rising	2.40	2.60	2.79	V
UVLO Hysteresis	$V_{UVLO-HYS}$			120		mV
Quiescent Supply Current	I_Q	Not switching		1.8		mA
Shutdown Supply Current	I_{SHDN}	EN tied to GND		0.1	1	μA
EN Logic High Voltage	V_{IN}		1.80			V
EN Logic Low Voltage	V_{IL}				0.8	V
EN Logic Input Current	I_{IL}, I_{IH}	$V_{IN} = 5.5V, V_{EN} = 0V$ or $5.5V$		± 0.01	± 1	μA
Thermal Shutdown Temperature	T_{SD}	T_J rising		155		$^\circ C$
Thermal Shutdown Hysteresis				20		$^\circ C$
Boost Converter Characteristics						
Switching Frequency	f_{SW}		680	800	920	kHz
Maximum Duty Cycle	D_{MAX}	$V_{IN} = 3.2V, T_A = 25^\circ C$	92			%
Minimum On-Time	$t_{ON(MIN)}$			100		ns
Switch Over-Current Protection	I_{OCP}		425		725	mA

Electrical Characteristics (continued)

Parameter	Symbol	Conditions	Min	Typ	Max	Units
Boost Converter Characteristics (continued)						
Switch Leakage Current	$I_{L(LX)}$	$V_{LX} = 5.5V$		0.01	1	μA
Switch Saturation Voltage	V_{SAT}	$I_{LX} = 0.3A$		250	450	mV
COMP Sourcing Current	I_{COMP}	$V_{COMP} = 0.9V, T_A = 25^\circ C$		5		μA
COMP Sinking Current		$V_{COMP} = 0.9V, T_A = 25^\circ C$		6		
OUT Over-Voltage Protection	V_{OVP}		38		43	V
OUT Internal Pull-Down Current	I_{OVP}	During OVP condition		1		mA
OUT Bias Current	I_{OUT}	$V_{EN} = V_{IN}, V_{OUT} = 20V$		50	70	μA
OUT Leakage Current		$V_{EN} = 0V, V_{OUT} = V_{IN} = 5.5V$		0.01	1	μA
PWM Dimming Frequency Range ⁽¹⁾⁽²⁾	f_{EN}	Applied to EN pin	100		50k	Hz
PWM Dimming Duty Cycle Range ⁽¹⁾⁽²⁾	D_{EN}	200Hz on EN pin	0		100	%
Current Sink Characteristics						
BL Current Setting Range ⁽³⁾	I_{BL}		1		30	mA
BL Current Setting Accuracy		$T_A = 25^\circ C$	-3.5		3.5	%
BL Leakage Current	$I_{L(BL)}$	$V_{EN} = 0V, V_{BL} = 2V$		0.01	0.1	μA
BL Current Line Regulation	$\Delta I_{BL} / \Delta V_{IN}$	$V_{IN} = 3.0$ to $5.5V$		± 0.05		mA/V
BL Voltage	V_{BL}			0.35		V
ISET Bias Voltage	V_{ISET}			0.5		V
ISET-to- I_{BL} Gain	A_{ISET}			230		A/A
Start-Up Time	$t_{start-up}$			1.3		μs

Notes:

- (1) Guaranteed by design.
- (2) See PWM Dimming description in the Applications Information section for limitations at high PWM dimming frequencies and low PWM dimming duty cycles.
- (3) Not recommended to program below 1mA with R_{ISET} due to tolerance stackup. To produce output current less than 1mA, set the current > 1mA and use PWM dimming.

Typical Characteristics

All data taken with $V_{OUT} = 20V$ (6 white LEDs), $R_{ISET} = 5.76k\Omega$ ($I_{BL} = 20mA$), $V_{IN} = 3.6V$, $L = 22\mu H$, and efficiency (η) = P_{LED}/P_{IN} unless otherwise noted.

Efficiency vs. I_{BL}

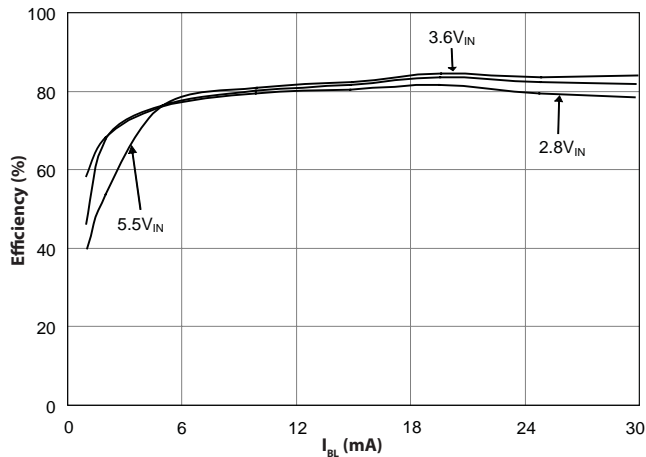

Efficiency vs. Output Voltage

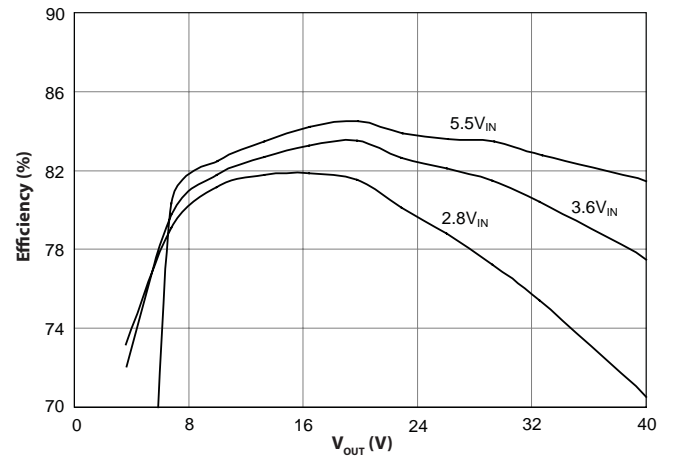

Efficiency vs. Input Voltage

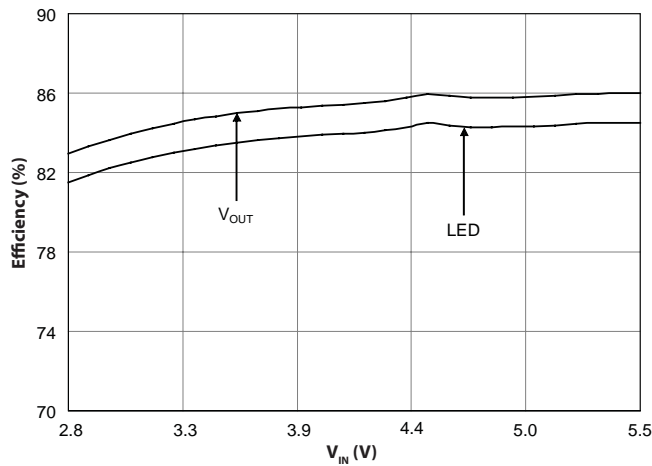

Efficiency vs. Input Voltage

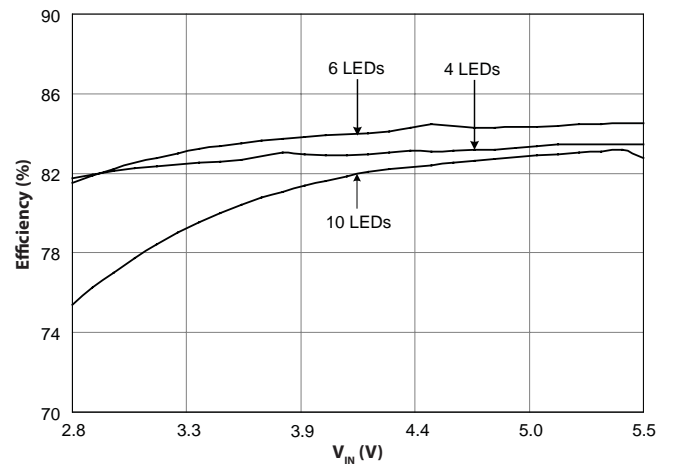

Efficiency vs. Input Voltage

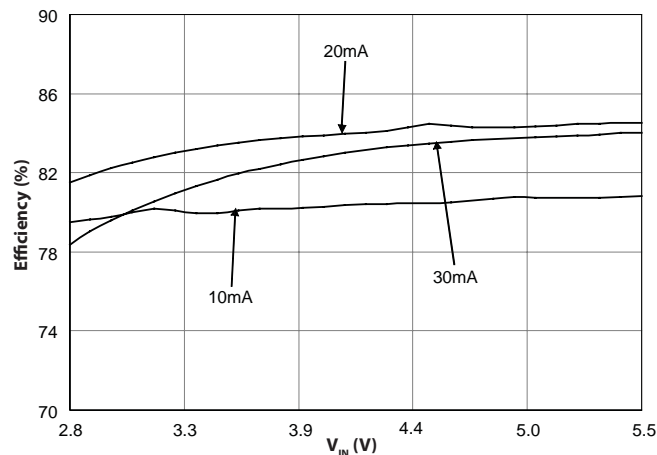

Normalized I_{BL} vs. Output Voltage

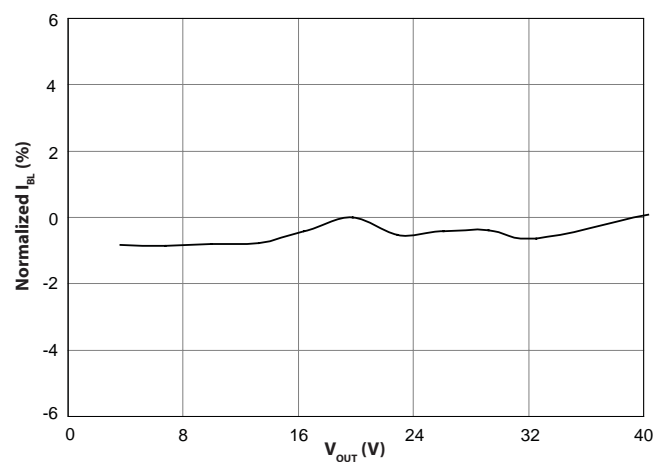

Typical Characteristics (continued)

PWM Operation at 200Hz and 1% Duty Cycle

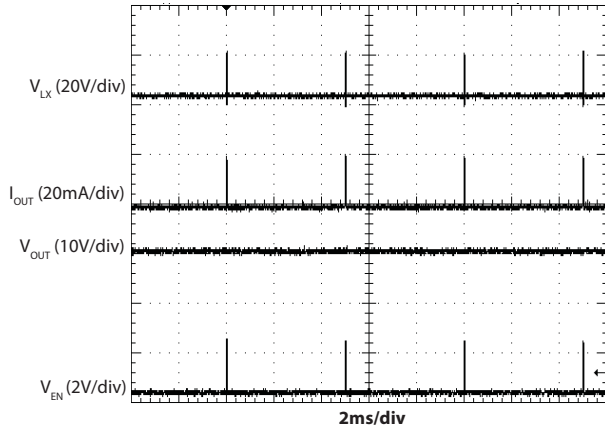

PWM Operation at 50kHz and 15% Duty Cycle

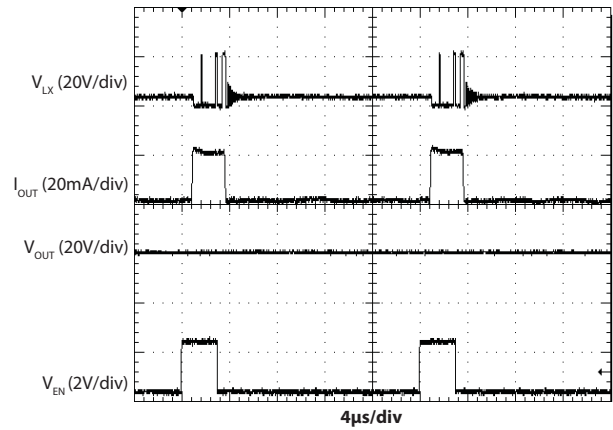

PWM Operation at 32kHz and 50% Duty Cycle

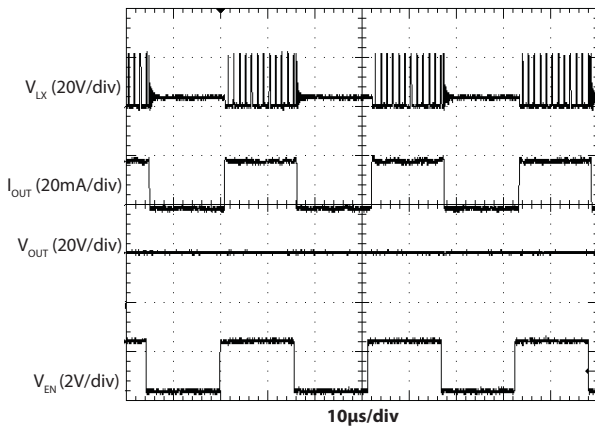

PWM Operation at 32kHz and 10% Duty Cycle

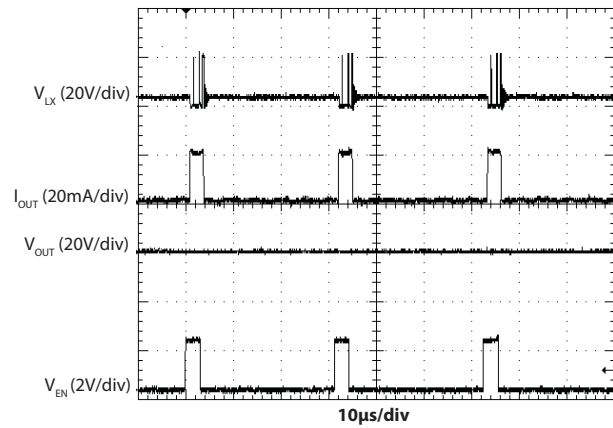

I_{BL} vs. Duty Cycle

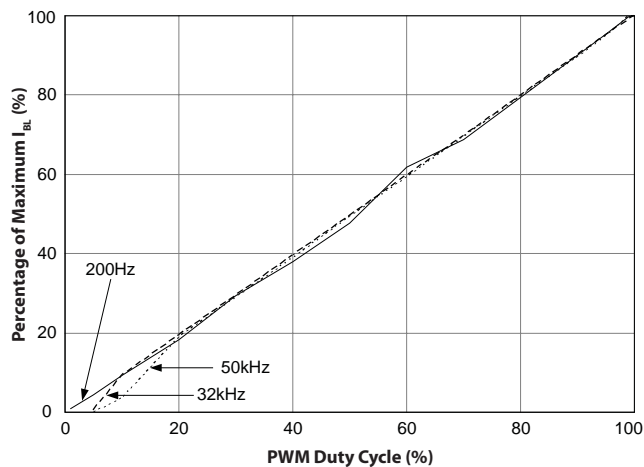

I_{BL} Error vs. PWM Frequency at 50% Duty Cycle

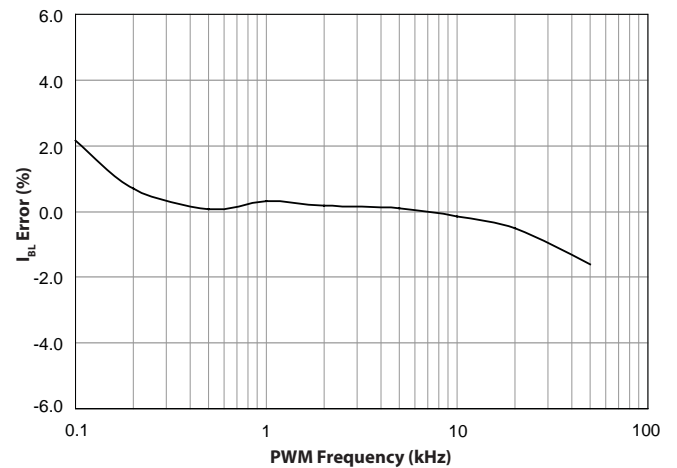

Typical Characteristics (continued)

Typical Waveforms at $V_{IN} = 2.8V$

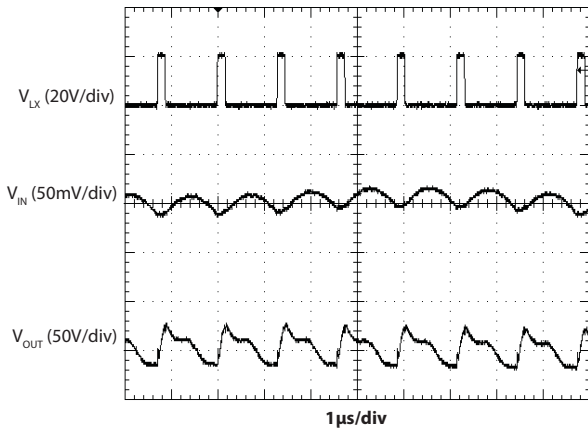

Typical Waveforms at $V_{IN} = 5.5V$

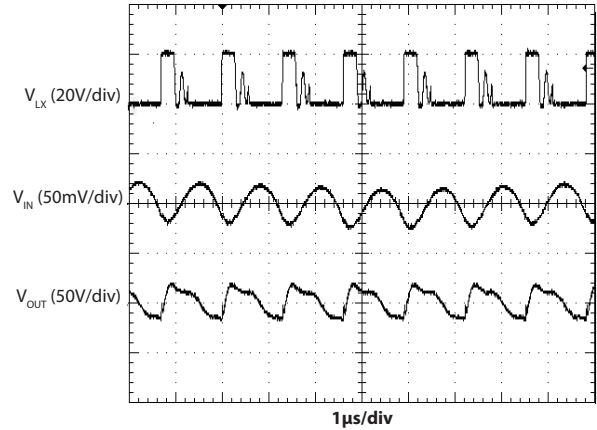

Typical Waveforms at $V_{IN} = 3.6V$

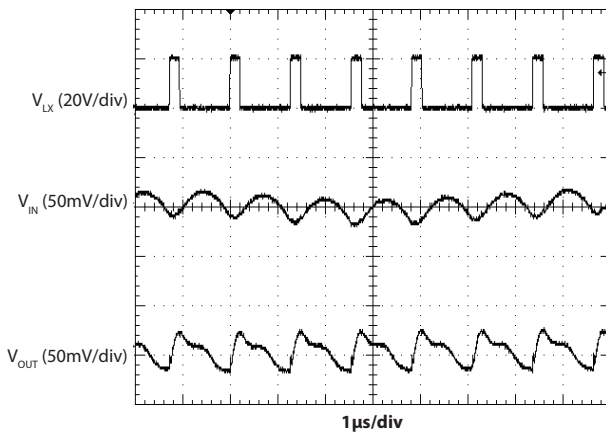

Start-Up Response

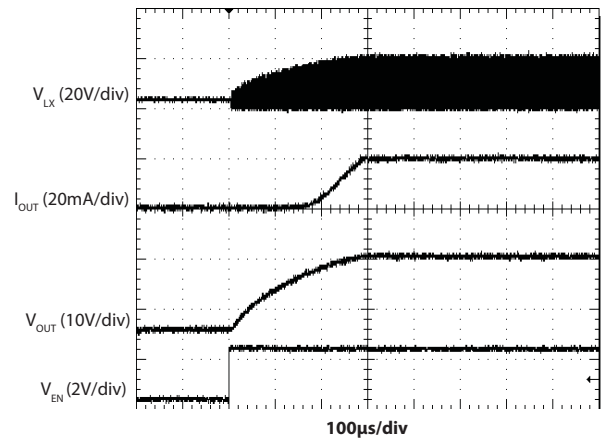

Waveforms During Over-Voltage Protection

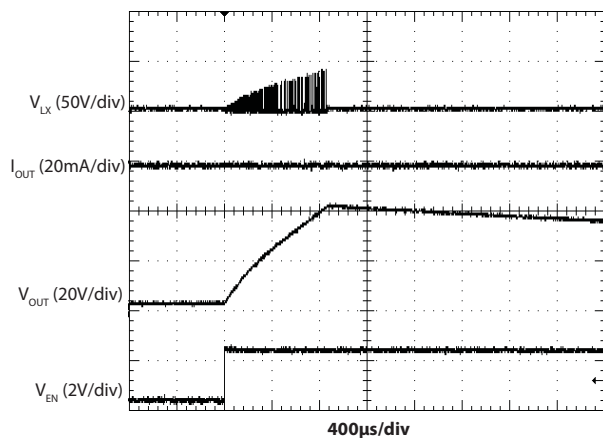

Normalized I_{BL} vs. Input Voltage

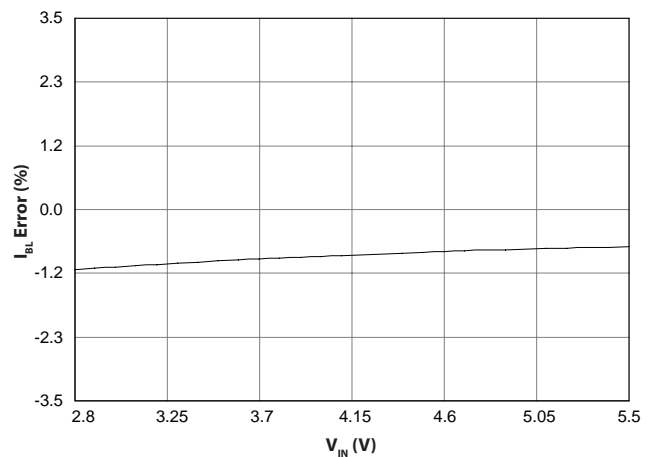

Pin Descriptions

Pin #	Pin Name	Pin Function
1	LX	Collector of the internal power transistor — connect to the boost inductor and rectifying Schottky diode.
2	EN	Enable and brightness control pin for LED string
3	ISET	Output current set pin — connect a resistor from this pin to GND to set the maximum current.
4	COMP	Output of the internal transconductance error amplifier — this pin is used for loop compensation and soft-start. Connect a 1.27k Ω resistor and 47nF capacitor in series to GND.
5	OUT	Boost output voltage monitor pin — internal over-voltage protection monitors the voltage at this pin. Connect this pin to the output capacitor and the anode of the LED string.
6	BL	LED constant current sink — connect this pin to the cathode of the LED string
7	GND	Ground
8	IN	Power supply pin — bypass this pin with a capacitor close to the pin
T	Thermal Pad	Pad for heatsinking purposes — connect to the ground plane using multiple vias. Not connected internally.

Block Diagram

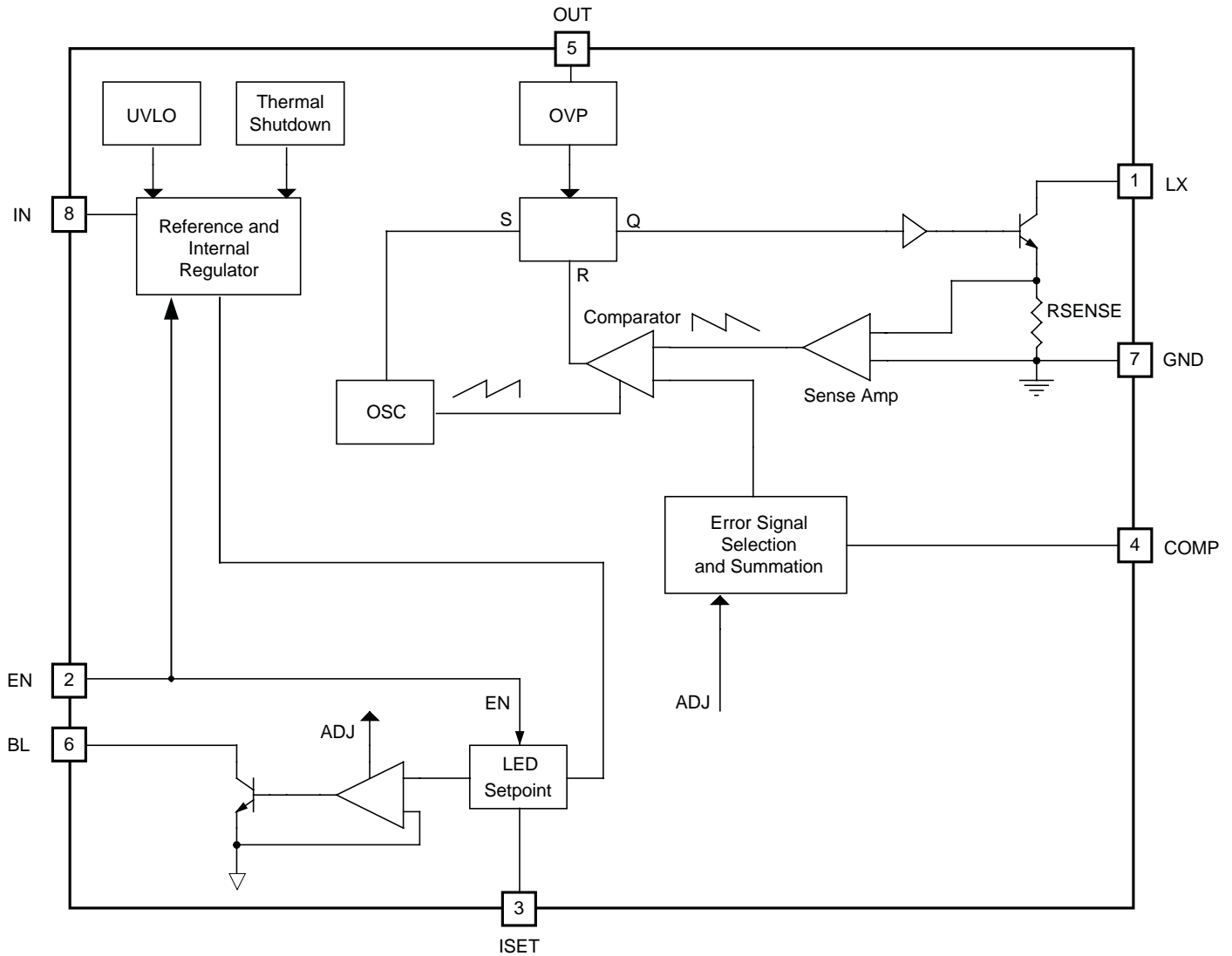

Applications Information

General Description

The SC4538 contains an 800kHz fixed-frequency current-mode boost converter and an independent LED current regulator. The LED current set point is chosen using an external resistor, while the PWM controller operates independently to keep the current in regulation. The SC4538 receives information from the internal LED current regulator and drives the output to the proper voltage with no user intervention.

The current flowing through the LED string is independently controlled by an internal current regulator, unlike the ballasting resistor scheme that many LED current regulators use. The internal current regulator can be shut off entirely without leaking current from a charged output capacitor or causing false-lighting with low LED count and high V_{IN} . The backlight current (I_{BL}) is programmed using an external resistor.

The path from the EN pin to the output control is a high bandwidth control loop. This feature allows the PWM dimming frequency to range between 100Hz and 50kHz. In shutdown mode, leakage through the current regulator output is less than 1 μ A. This keeps the output capacitor charged and ready for instant activation of the LED string.

The 800kHz switching speed provides high output power while allowing the use of a low profile inductor, maximizing efficiency for space constrained and cost-sensitive applications. The converter and output capacitor are protected from open-LED conditions by over-voltage protection.

PWM Dimming

The enable pin can be toggled to allow PWM dimming. In a typical application, a microcontroller sets a register or counter that varies the pulse width on a GPIO pin. The SC4538 provides dimming between 100Hz and 50kHz. The SC4538 is compatible with a wide range of devices, allowing dimming strategies that avoid the audio band by using high frequency PWM dimming. A wide range of illumination can be generated while keeping the instantaneous LED current at its peak value for luminescent efficiency and color purity. The SC4538 can accommodate any PWM duty cycle between 0 and 100%. A low duty

cycle PWM signal used for a few milliseconds provides the additional advantage of reduced in-rush at start up.

The start-up delay time between the enable signal going high and the activation of the internal current regulator causes nonlinearity between the I_{BL} current and the duty cycle of the PWM frequency seen by the EN pin. As the PWM signal frequency increases, the total on time per cycle of the PWM signal decreases. Since the start up delay time remains constant, the effect of the delay becomes more noticeable, causing the average I_{BL} to be less predictable at lower duty cycles. Recommended minimum duty cycles are 20% for 50kHz PWM frequency, 15% for 32kHz PWM frequency and 2% for 200Hz PWM frequency. Refer to the I_{BL} vs. Duty Cycle in the Typical Characteristics section for PWM performance across duty cycle for different PWM frequencies.

Zero Duty Cycle Mode

Zero duty cycle mode is activated when the voltage on the BL pin exceeds 1.3V. In this mode, the COMP pin voltage is pulled low, suspending all switching. This allows the V_{OUT} and V_{BL} voltages to fall. The COMP voltage is held low until the V_{BL} falls below 1V, allowing V_{COMP} to return to its normal operating voltage and switching to resume.

Protection Features

The SC4538 provides several protection features to safeguard the device from catastrophic failures. These features include:

- Over-voltage Protection (OVP)
- Soft-start
- Thermal Shutdown
- Current Limit

Over-Voltage Protection (OVP)

A built-in over-voltage protection circuit prevents damage to the IC and output capacitor in the event of an open-circuit condition. The output voltage of the boost converter is detected at the OUT pin and divided internally. If the voltage at the OUT pin exceeds the OVP limit, the boost converter is shut down and a strong pull down is applied to the OUT pin to quickly discharge the output capacitor. This additional level of protection prevents a condition where the output capacitor and Schottky diode

Applications Information (continued)

must endure high voltage for an extended period of time.

Soft-Start

The soft-start mode reduces in-rush current by utilizing the external compensation network. As the error amplifier slowly charges the COMP node voltage, the duty cycle of the boost switch ramps from 0% to its final value once in regulation. The gradual increase of the duty cycle slowly charges the output capacitor and limits in-rush current during start up. Soft-start is implemented only when the input power is cycled.

Thermal Shutdown

A thermal shutdown system is included for protection in the event the junction temperature exceeds 155°C. In thermal shutdown, the on-chip power switch is disabled. Switching and sinking resumes when the temperature drops by 20°C.

Current Limit

The power switch of the boost converter is protected by an internal current limit function. The switch is opened when the current exceeds the maximum switch current value.

Inductor Selection

The inductor value should be within the range of 4.7µH to 22µH. The DCR needs to be considered when selecting the inductor to ensure optimum efficiency. The largest inductor package that can be tolerated in the circuit area should be used since the DCR generally decreases with increasing package size.

The saturation current of the inductor should be much higher than the peak current of the internal boost switch to ensure that the inductor never enters saturation during normal operation of the part. The equation to calculate the peak inductor current is:

$$I_{L(\text{Peak})} = I_{\text{IN}} + \frac{\Delta I_L}{2}$$

where

$$\Delta I_L = \frac{V_{\text{IN}} \times D}{L \times f_{\text{osc}}}$$

$$D = 1 - \frac{V_{\text{IN}}}{V_{\text{OUT}}}$$

$$I_{\text{IN}} = \frac{V_{\text{OUT}} \times I_{\text{OUT}}}{\eta \times V_{\text{IN}}}$$

D is the duty cycle for continuous operation. Efficiency (η) can be approximated by using the curves provided in the Typical Characteristics section. Table 1 lists inductors that have been proven to work with SC4538.

Table 1 -- Recommended Inductors

Part Number	Value (µH)	DCR (Ω)	Rated Current (A)	Tolerance	Dimensions (L x W x H) (mm)
Coilcraft LPS4018-223ML	22	0.360	0.70	±20%	3.9 x 3.9 x 1.7
Murata LQH43CN150K03	15	0.320	0.570	±10%	4.5 x 3.2 x 2.6
Murata LQH32CN150K53	15	0.580	0.300	±10%	3.2 x 2.5 x 1.55

Capacitor Selection

The input capacitor should be at least 2.2µF. A larger capacitor will reduce the voltage ripple on the input. The output capacitor values can range from 0.22µF to 1µF. The compensation capacitor value should be 47nF. Capacitors of X5R type material or better can be used for any of the capacitors. See Table 2 for the recommended capacitors.

Table 2 -- Recommended Capacitors

Part Number	Value (µF)	Rated Voltage (V)	Type	Case Size
Input Capacitor				
Murata GRM188C70J225KE20	2.2	6.3	X7S	0603
Output Capacitor				
Murata GRM21BR71H105KA12L	1.0	50	X7R	0805
Compensation Capacitor				
Taiyo Yuden EMK105BJ473KV-F	0.047	16	X7R	0402

Applications Information (continued)

Diode Selection

A Schottky diode with a reverse voltage of 40V and a forward current rating of 1A should be used with this device for optimum performance. The Central Semiconductor Corporation CMOSH-4E is a suitable diode for this application.

Selection of Other Components

R_{ISET} sets the maximum load current for the SC4538. Use the following equation to select the proper value:

$$R_{ISET} = 230 \times V_{ISET} / I_{LOAD}$$

where

$$V_{ISET} = 0.5V \text{ (typ.)}$$

Refer to Figure 1 for selecting values for other current settings. Notice that the error increases as the desired I_{BL} current decreases.

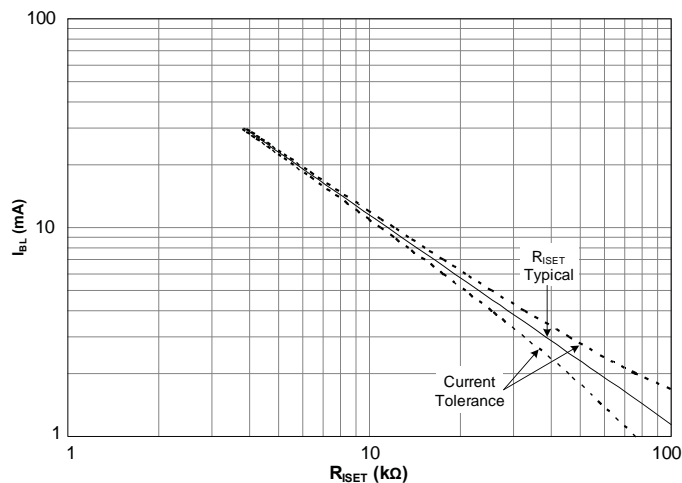

Figure 1 – Set Resistor Value Selection Graph

PCB Layout Considerations

Poor layout can degrade the performance of the DC-DC converter and can be a contributory factor in EMI problems, ground bounce, thermal issues, and resistive voltage losses. Poor regulation and instability can result. A typical layout is shown in Figure 2.

The following design rules are recommended:

- Place the inductor and filter capacitors as close to the device as possible and use short, wide traces between the power components.
- Route the output voltage feedback path away from the inductor and LX node to minimize noise and magnetic interference.
- Use a ground plane to further reduce noise interference on sensitive circuit nodes.

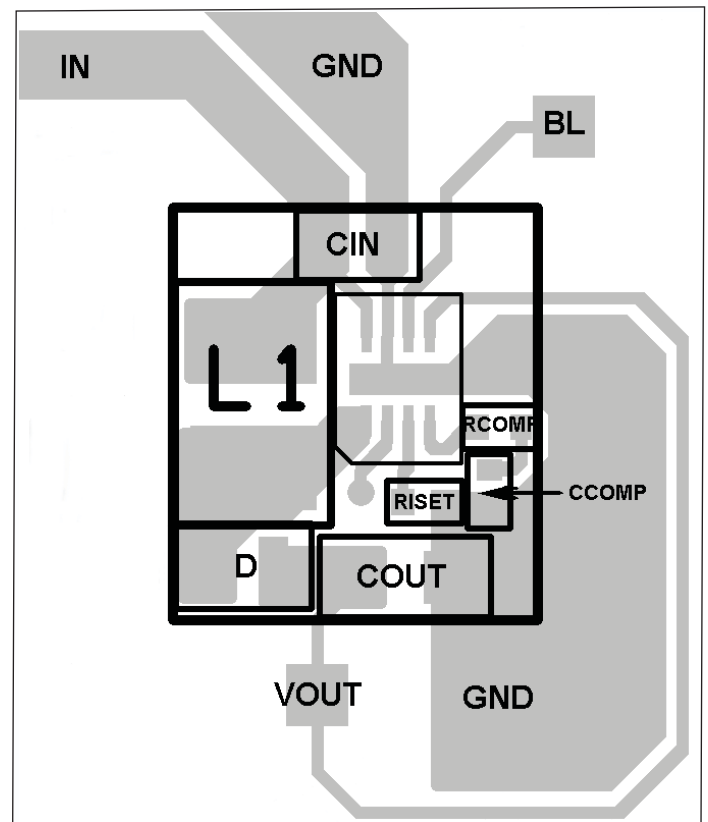
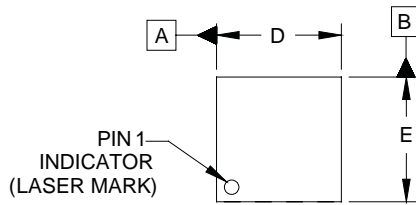
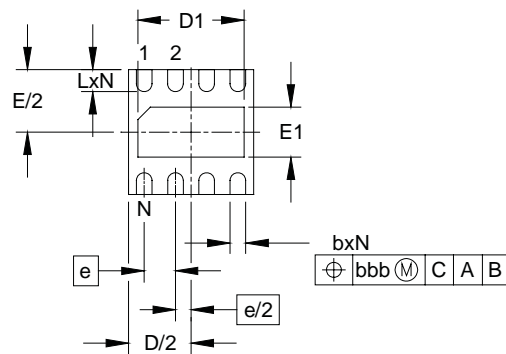
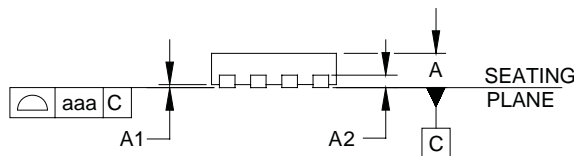

Figure 2– Layout

Outline Drawing – MLPD-UT-8 2x2

DIM	INCHES			MILLIMETERS		
	MIN	NOM	MAX	MIN	NOM	MAX
A	.020	-	.024	0.50	-	0.60
A1	.000	-	.002	0.00	-	0.05
A2	(.006)			(0.1524)		
b	.007	.010	.012	0.18	0.25	0.30
D	.075	.079	.083	1.90	2.00	2.10
D1	.061	.067	.071	1.55	1.70	1.80
E	.075	.079	.083	1.90	2.00	2.10
E1	.026	.031	.035	0.65	0.80	0.90
e	.020 BSC			0.50 BSC		
L	.012	.014	.016	0.30	0.35	0.40
N	8			8		
aaa	.003			0.08		
bbb	.004			0.10		

NOTES:

1. CONTROLLING DIMENSIONS ARE IN MILLIMETERS (ANGLES IN DEGREES).
2. COPLANARITY APPLIES TO THE EXPOSED PAD AS WELL AS THE TERMINALS.

Land Pattern – MLPD-UT-8 2x2

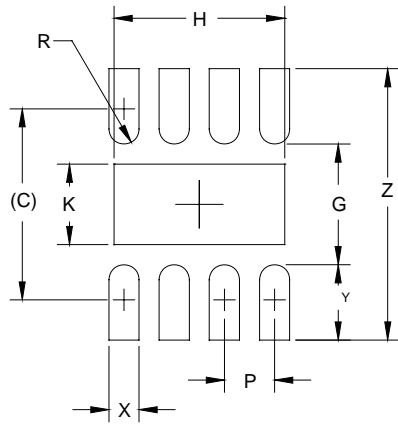

DIMENSIONS		
DIM	INCHES	MILLIMETERS
C	(.077)	(1.95)
G	.047	1.20
H	.067	1.70
K	.031	0.80
P	.020	0.50
R	.006	0.15
X	.012	0.30
Y	.030	0.75
Z	.106	2.70

NOTES:

1. CONTROLLING DIMENSIONS ARE IN MILLIMETERS (ANGLES IN DEGREES).
2. THIS LAND PATTERN IS FOR REFERENCE PURPOSES ONLY. CONSULT YOUR MANUFACTURING GROUP TO ENSURE YOUR COMPANY'S MANUFACTURING GUIDELINES ARE MET.
3. THERMAL VIAS IN THE LAND PATTERN OF THE EXPOSED PAD SHALL BE CONNECTED TO A SYSTEM GROUND PLANE. FAILURE TO DO SO MAY COMPROMISE THE THERMAL AND/OR FUNCTIONAL PERFORMANCE OF THE DEVICE.

Contact Information

Semtech Corporation
 Power Management Products Division
 200 Flynn Road, Camarillo, CA 93012
 Phone: (805) 498-2111 Fax: (805) 498-3804

www.semtech.com